

SKiiP 320 TAT ... D - SKiiP 450 TAT ... D - SKiiP 500 TAT ... D

V _{RMS} V	V _{DRM} V _{RRM} V	I _{RMS} for continuous operation, T _{amb} = 35 °C, mounted on heatsink P16/260F with radial fan SKF 16B-230-01				
		3 x 325 A	3 x 445 A	3 x 520 A	recom. RC snubber	
		SKiiP	SKiiP	SKiiP	R/Ω	C/μF
230 ²⁾	800	320 TAT 08	450 TAT 08	500 TAT 08	47	0.22
400 ³⁾	1400	320 TAT 14	450 TAT 14	500 TAT 14	68	0.1
500 ³⁾	1600	320 TAT 16	450 TAT 16	500 TAT 16	68	0.1

Absolute Maximum Ratings

Symbol	Conditions	320TAT	450TAT	500TAT	Units
I _{RMS} ⁴⁾	t = ∞	325	445	520	A
	t = 1 s	1125	1625	2190	A
	t = 5 s	830	1115	1395	A
	t = 10 s	680	902	1135	A
I _{TSM} i ² t	T _{vj} = 130 °C, 10 ms	5000	8000	12000	A
	T _{vj} = 130 °C, 10 ms	125	320	720	kA ² s
R _{thja} ⁵⁾	325 m ³ /h air flow	0.076	0.062	0.055	K/W
h	altitude	sea level			m
V _{isol}	a.c. 50 Hz; rms; 1 s/1 min	3000/2500			V~
T _{vj}		- 40 ... + 130			°C
T _{stg}	with/without trigger board	- 40 ... + 85 / - 40 ... + 130			°C
R _{temp}	T _c = 25 °C, I _{hom} = 1 mA	1000			Ω

Electrical Characteristics

Trigger Characteristics

(di/dt) _{CR}	T _{vj} = 130 °C	100	100	125	A/μs
t _q	T _{vj} = 130 °C, typ.	100	100	150	μs
I _H	T _{vj} = 20 °C, typ.	150	150	500	mA
V _{GT}	T _{vj} = 25 °C, d.c.	3	3	3	V
I _{GT}	T _{vj} = 25 °C, d.c.	200	250	200	mA
V _{GD}	T _{vj} = 130 °C, d.c.	0.25	0.25	0.25	V
I _{GD}	T _{vj} = 130 °C, d.c.	10	10	10	mA

Driver Board (typical values)

V _{IT+}	Input threshold HIGH	3.25	V
V _{IT-}	Input threshold LOW	1.35	V
V _{CC}	Logic power supply	5.00 ± 0.25	V
I _{CC}	Logic input current	≤ 2	mA
V ₊	Driver power supply	22.0 ± 4.4	V
I _{V+}	Driver input current	≤ 800	mA
f _{CLK}	Internal clock frequency	5.0 ± 0.8	kHz

Mechanical Data

a	acceleration	5 x g (g = 9.81)	m/s ²
w	approx.	7.4	kg
M	busbars to terminals	22.5 ± 2.5	Nm

SKiiP® W3C Thyristor 3 ~ AC Switch

SKiiP 320 TAT ... D¹⁾
SKiiP 450 TAT ... D¹⁾
SKiiP 500 TAT ... D¹⁾

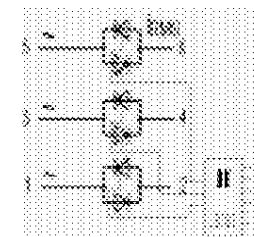
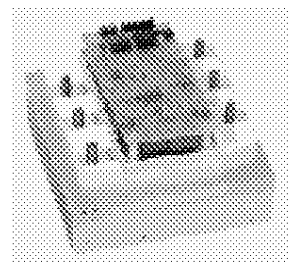

Features

- Isolated heatsink
- Aluminium oxide ceramic substrate
- Integrated power for 3 ~ AC applications
- RC snubbers
- Complete thyristor trigger circuit including 5 kHz generator and pulse transformers
- Blocking voltage up to 1.6 kV
- Pressure contact for high reliability
- base-plate temperature monitoring (PTC)

Typical Applications

- Soft-starters
- Electric ovens
- Resistance welding
- General AC power control for three phase lines
- Professional light dimming

¹⁾ Code designation for orders
... TAT .. = no trigger board
... TAT .. D = with trigger board on request

²⁾ dv/dt = 500 V/μs

³⁾ dv/dt = 1000 V/μs

⁴⁾ „cold-start“ absolute maximum current, T_{amb} = 35 °C, T_{vj} = 130 °C

⁵⁾ Value for complete W3C assembly

⁶⁾ Recommended fan: SKF 16B-230-01, see page: B14-101, has to be ordered separately!

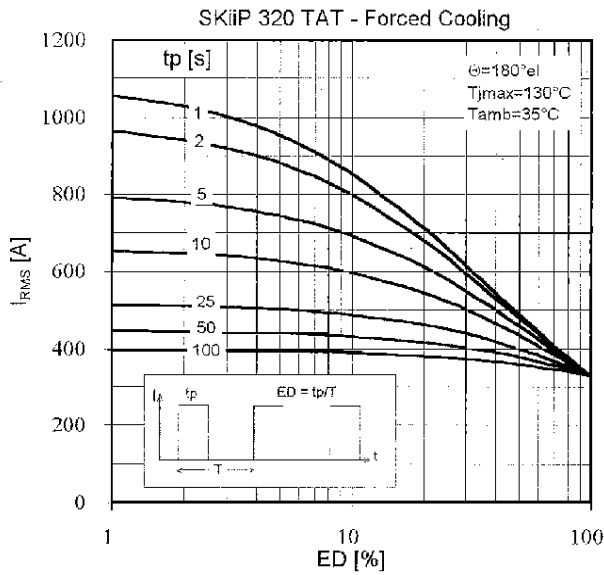

Fig. 1a Maximum rms current vs. duty cycle

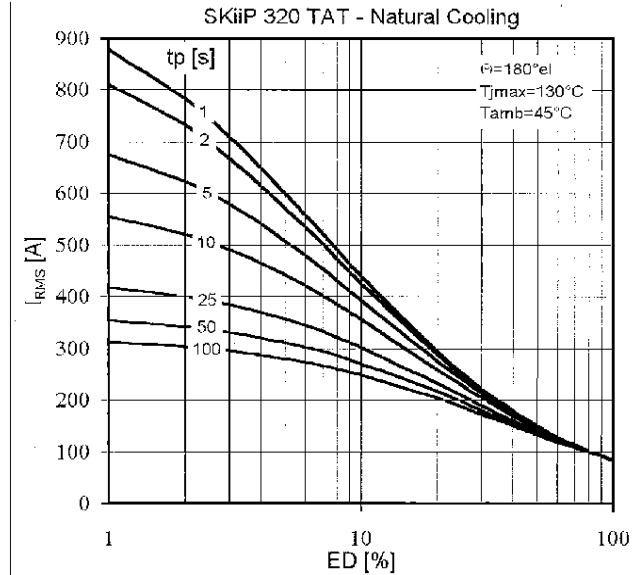

Fig. 2a Maximum rms current vs. duty cycle

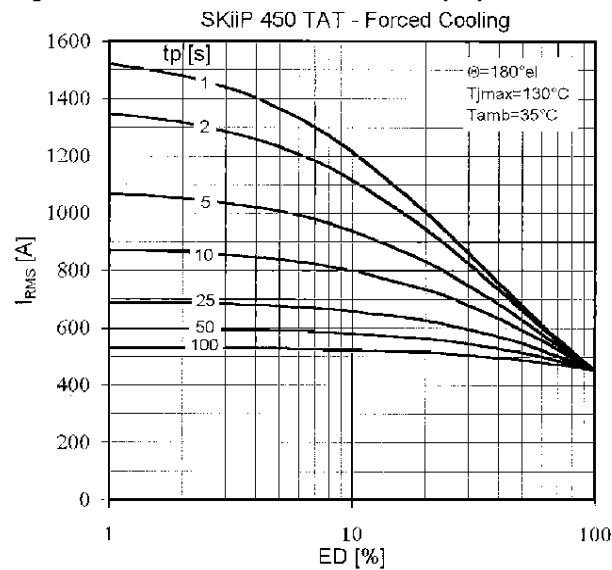

Fig. 1b Maximum rms current vs. duty cycle

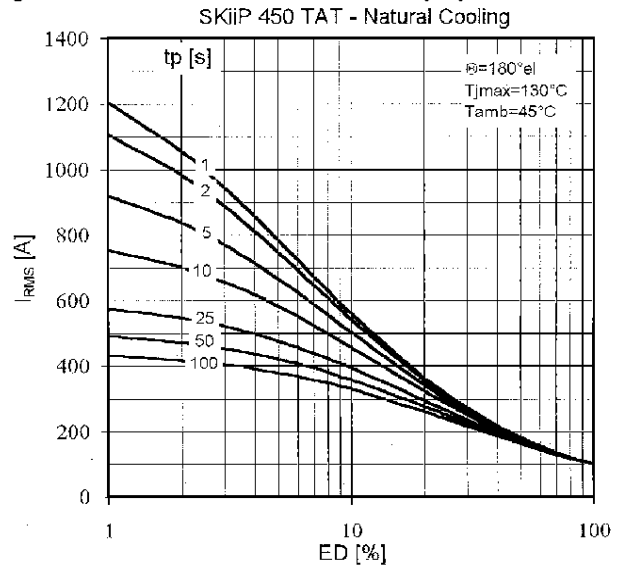

Fig. 2b Maximum rms current vs. duty cycle

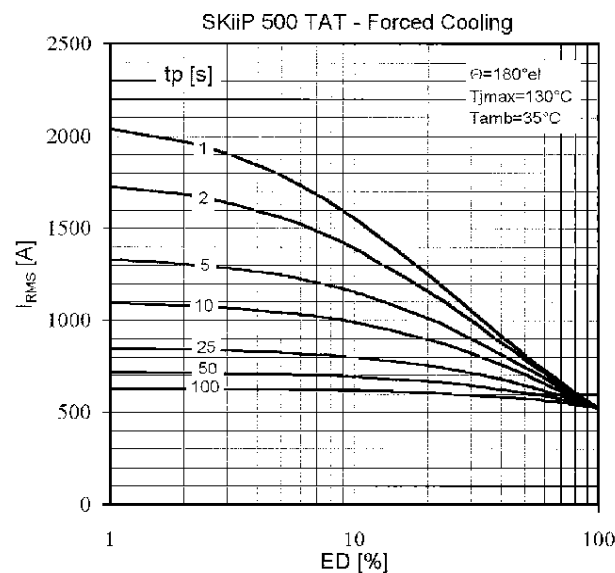

Fig. 1c Maximum rms current vs. duty cycle

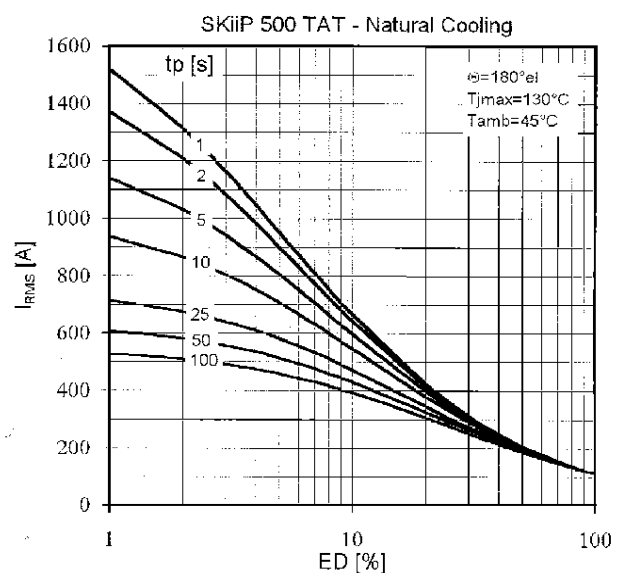

Fig. 2c Maximum rms current vs. duty cycle

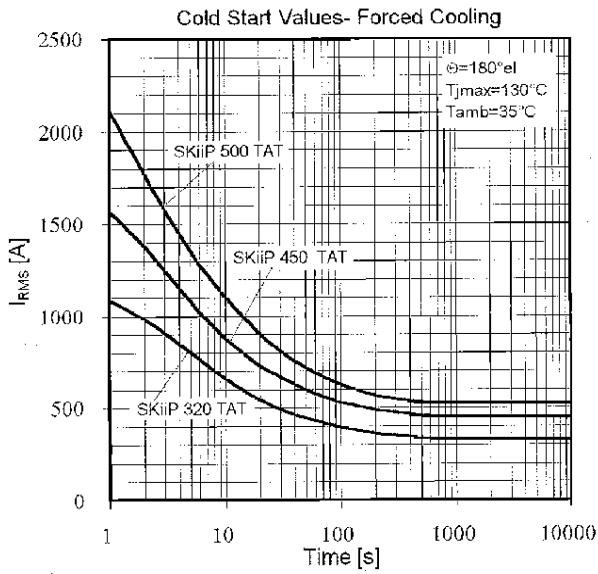

Fig. 3 Maximum rms current vs. time

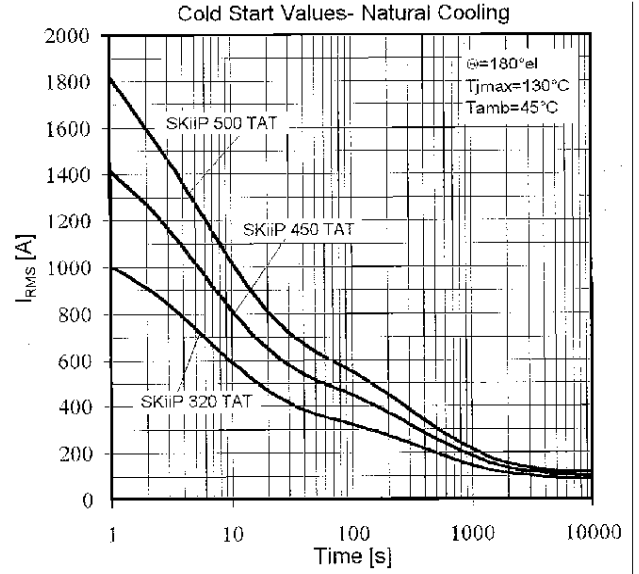

Fig. 4 Maximum rms current vs. time

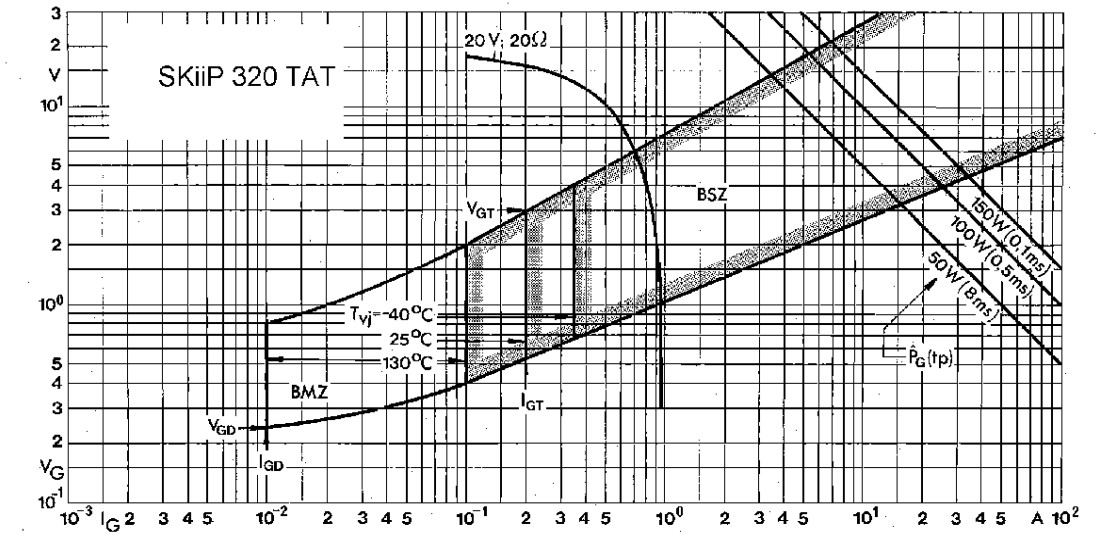

Fig. 10a Gate trigger characteristics (per thyristor)

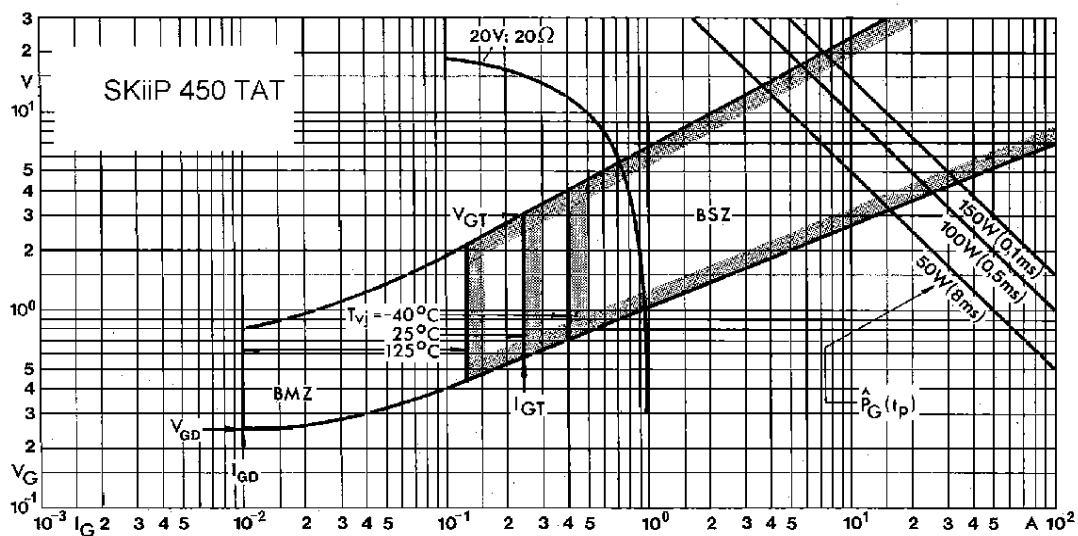

Fig. 10b Gate trigger characteristics (per thyristor)

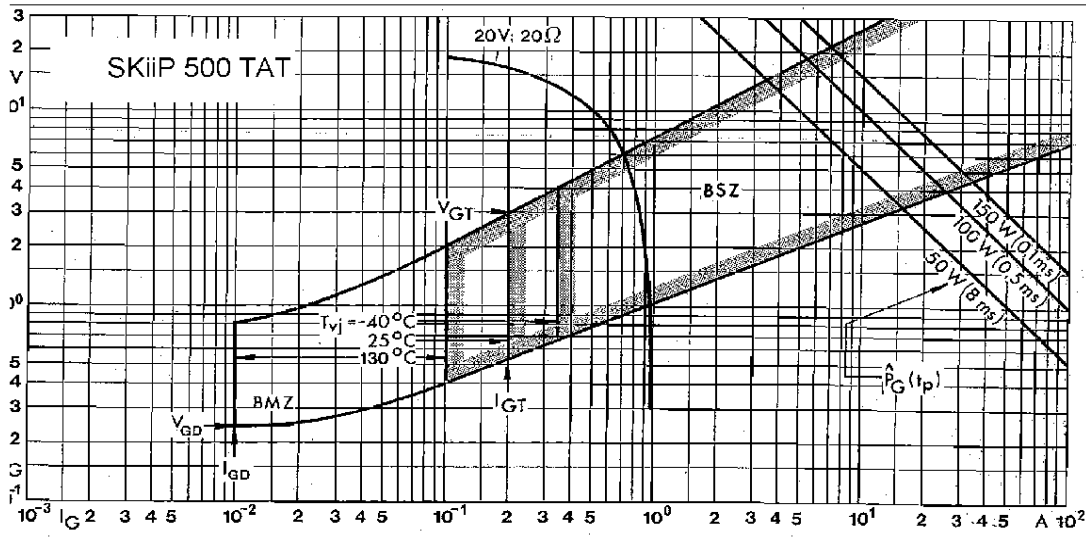
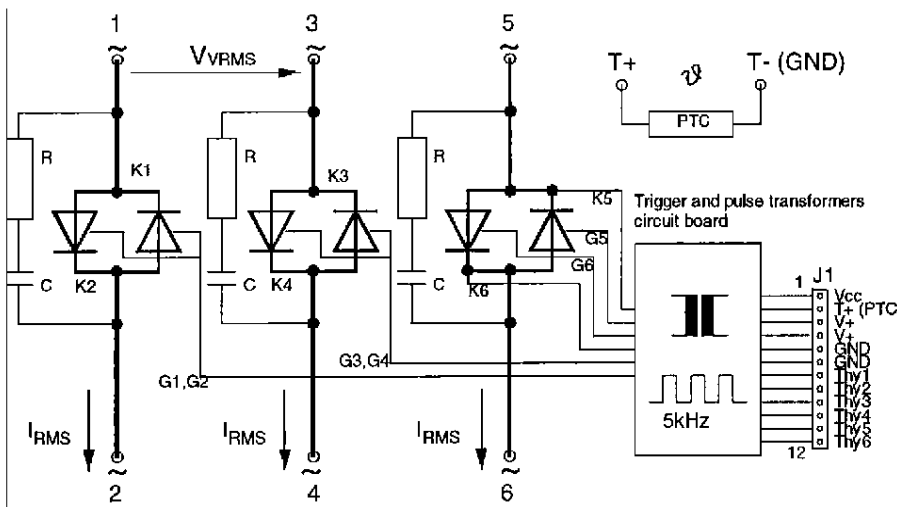

Fig. 10c Gate trigger characteristics (per thyristor)



The trigger board includes the necessary RC snubber and the pulse transformers with drivers.

Further information on request.

Fig. 12 Block diagramm: K1 ... K4 and G1 ... G4 have same internal connections to trigger boards as K5, K6 and G5, G6

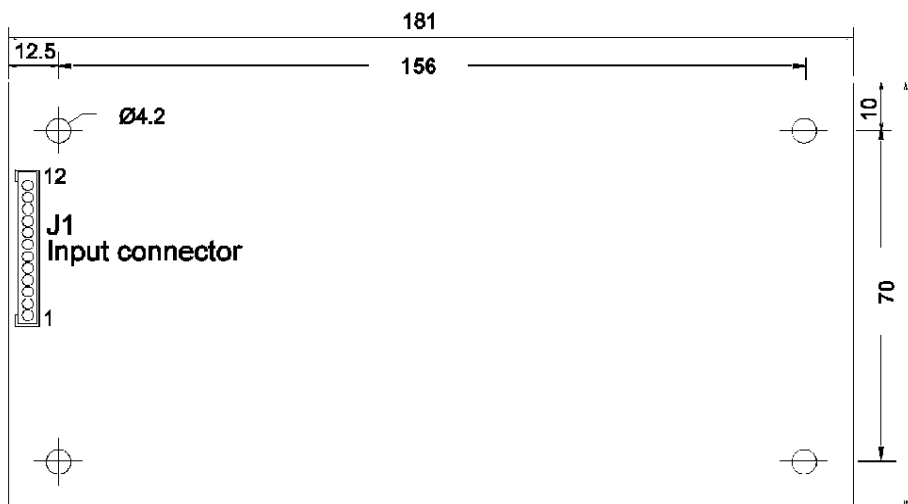

If the trigger board is requested, the only necessary input signals are the thyristors pulses (TTL level) and two auxiliary power supplies, i.e., V_{CC} (for the TTL logic) and V_+ (for the driver).

The driver circuit is able to deliver burst pulses of about $30 \mu s$ duration at 5 kHz and a maximum peak current of 850 mA.

J1 = B12B-XH-A 2.5 mm pitch disconnectable crimp style connector from JST (or equivalent)

Fig. 13 Trigger board SKPC 1016 - W3C (view from above). Dimensions in mm

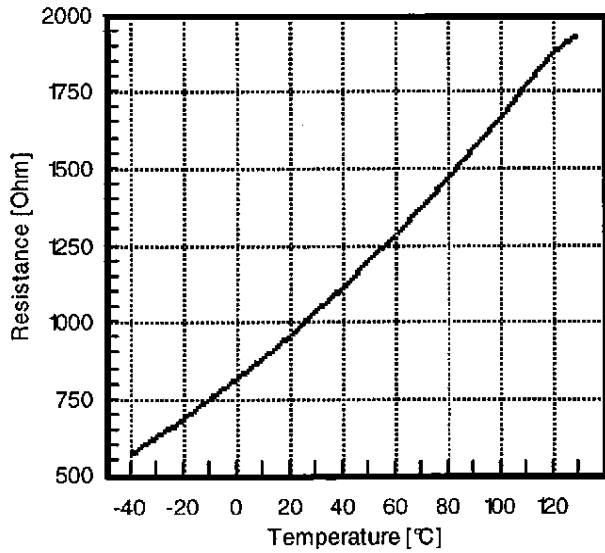
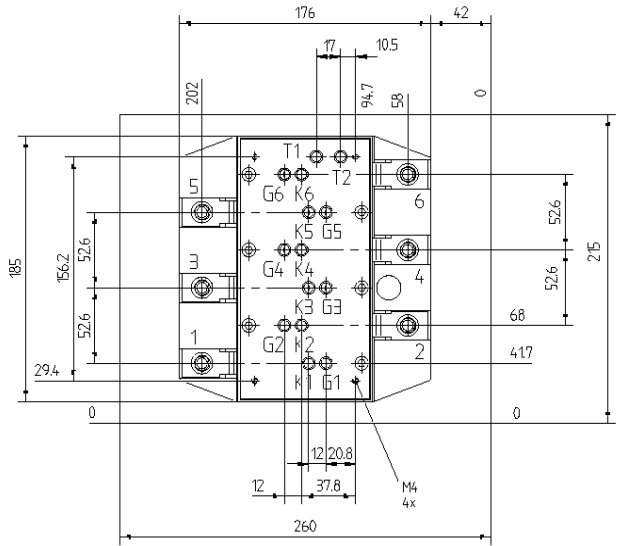
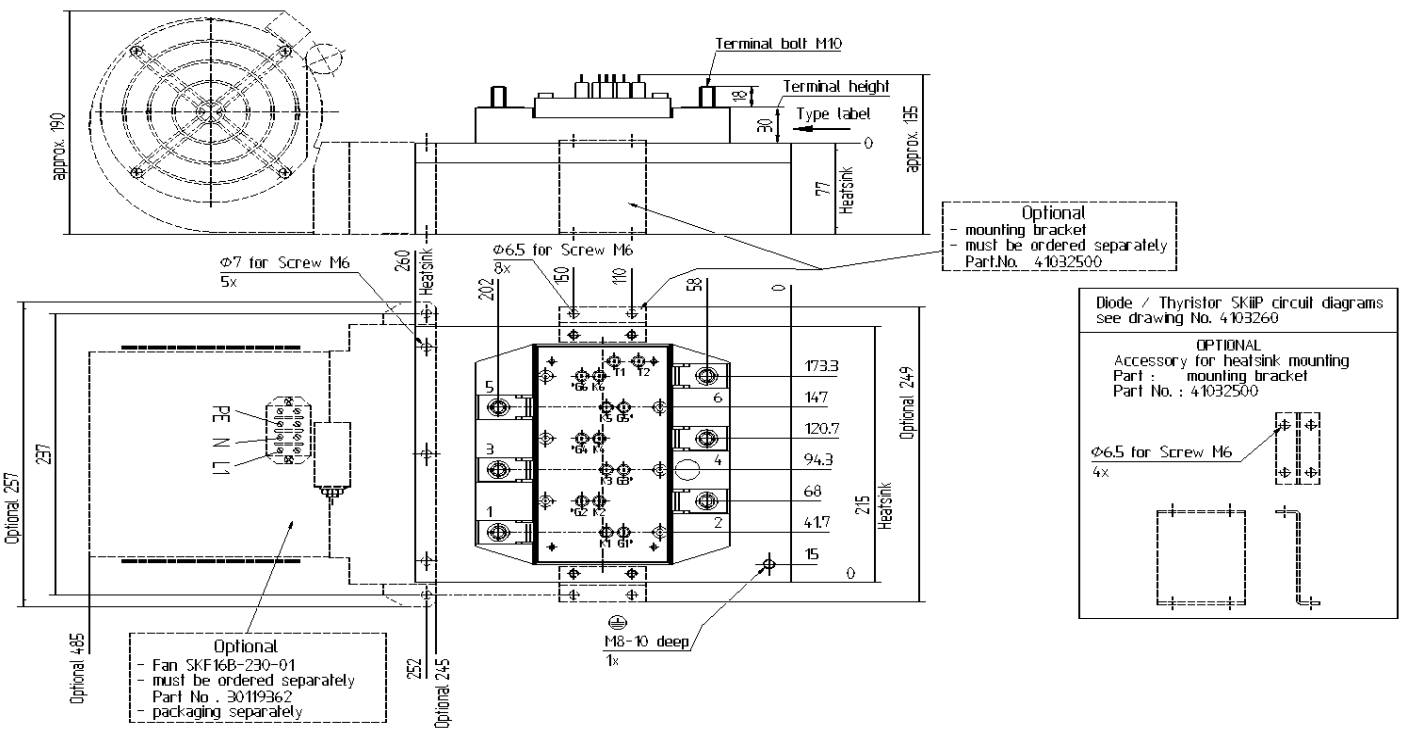

Fig. 14 Temperature sensor characteristic.



Nominal supply current = 1 mA
Fig. 15 Case S6 mechanical outline (in mm) without fan



* Gate terminals only active with Thyristor (chips) circuits

Fig. 16 Mechanical outline (in mm) with optional fan and mounting hardware

Fan has to be ordered separately (Id. No. 30119362)